



Installation and user manual

Unisenza Plus - Electronic Thermostatic Head

EN



Smart, app
connectivity



Battery
powered



Geo Location



5 year
guarantee



Release	Date
First release	August 2023



Index

1	Safety warnings	4
	Pictograms used in this manual.....	4
	Purpose of the manual.....	4
	Intended use.....	4
	Safety regulations.....	5
2	Technical data	6
	Unisenza Plus Electronic Thermostatic Head.....	6
3	Dimensions	7
4	Pack contents	7
5	Overview	8
	Unisenza Plus Electronic Thermostatic Head.....	8
	Display icons.....	8
	Button usage.....	9
6	Download the APP	10
7	Nameplate	10
8	Installation	11
	Recommendations for a correct installation	11
	Heating system compatibility.....	11
	Inserting the batteries	12
	Installation on standard valve.....	13
	Installation on Danfoss RA valve	14
9	Use	15
	Main screen operation.....	15
	Power up.....	15
	Joining to Unisenza Plus Gateway.....	16
	Valve calibration	18
	Pairing with other Unisenza Plus device (optional)	19
	Change operation mode.....	21
	Change set point in Manual mode	22
	Temporarily change set point in Schedule mode	22
	Off mode with frost protection	23
	Window open mode	23
	Valve protection	23
	Alert / Error code.....	23
10	Maintenance	24
	Low battery.....	24
	Over-the-air (OTA) software update operation	24
	Factory reset.....	24
	Cleaning	25
11	Manual download and updates	26
12	Disposal at the end of life	26

1 SAFETY WARNINGS

Pictograms used in this manual

To make reading clearer and more enjoyable, three types of symbols have been used in this manual to convey to the reader the meaning or importance of the information provided:



Hazard signs. Triangular framed shape. Indicate prescriptions relating to present or possible dangers.



Prohibition signs. Circular, barred frame. Indicate prescriptions relating to actions that must be avoided.



Mandatory signs. Full circle. Indicate information that is important to read and comply with.

Purpose of the manual

The purpose of this manual is to guide the qualified installer the installation, maintenance and proper and safe use of the equipment.



For this reason, it is mandatory for all personnel involved in the installation, maintenance and use of the equipment to read this manual.

Contact the Manufacturer if any points are unclear or difficult to understand.

This manual contains information regarding:

- Technical specifications of the equipment;
- Installation and connection instructions.

Intended use

The **Unisenza Plus Electronic Thermostatic Head** is an **electronic thermostatic** radiator valve (TRV) controller with wireless communication function for the replacement of an existing passive head on the standard **TRV** in a hydronic heating system. It has the latest **ZigBee 3.0 wireless technology** for easy integration with a smart heating solution for individual radiator controls.

Its features are:

- Built-in dual thermal sensors for accurate temperature control
- LCD display with backlight
- With button for quick set point adjustment
- Support schedule program

- Modulating control algorithm optimizes the energy efficiency and comfort
- Open window detection function for energy savings
- Support standard M30 x 1.5 mm valve connection with optional adaptor to support RA valve types
- 2xAA batteries operated

Safety regulations

Before proceeding with any installation or use, it is necessary to thoroughly inspect the product. Make sure that all the information contained in this manual correspond exactly to the purchased equipment. In the event that differences are identified, it is necessary to contact the Manufacturer in order to obtain the assistance and specific technical information necessary to operate.



Read this manual carefully before the installation, use and maintenance of the product and keep it for any further future consultation by the various operators.



All installation, assembly, electrical connections to the mains and ordinary/extraordinary maintenance must be performed **only by qualified personnel or technicians complying with the legal requirements.**

Installation, use or maintenance other than those specified in the manual may cause damage, injury or death, invalidate the warranty and relieve the Manufacturer of all liability.

Disconnect the equipment from the mains before installing or maintaining it.

Do not install the equipment outdoors. The product has been designed to be installed indoors, protected from bad weather, in places where the temperature is between 0 and +50 °C.

At the end of the installation it is necessary to instruct the user in the correct use of the equipment.

2 TECHNICAL DATA

Unisenza Plus Electronic Thermostatic Head

Temperature Scale	°C or °F
Temperature display range	0°C - 40°C (32°F - 104°F)
Temperature display resolution	0.5°C (1°F)
Temperature setting range	5°C - 35°C (41°F - 95°F)
Temperature setting resolution	0.5°C (1°F)
Temperature measurement accuracy	+/-1°C @ 15-25°C, +/-1.5°C other range
Valve connection	M30 x 1.5 mm or M28 x 1.5 mm versions available
Stroke travel	4.0 mm
Firmware update	Over the air firmware update capability
Wireless Communication	ZigBee 3.0, 2.4GHz
Power Supply	2 x AA-sized Alkaline Batteries
Operating environment	Indoor, residential & commercial
Operating temperature	0°C – 50°C
Storage temperature	-10°C – 60°C
Operating/Storage humidity	10-95% RH, non-condensing
Dimensions	58(W) x 58(D) x 96(H) mm
Ingress protection rating	IP20
Regulation	CE, UKCA
Environmental requirement	RoHS compliance

The **Unisenza Plus Electronic Thermostatic Head** complies with the following European directives:

- RED directive 2014/53/EU
- ROHS directive 2011/65/EU
- REACH (EC 1907/2006)

The **Unisenza Plus Electronic Thermostatic Head** complies with the relevant UK Statutory Instruments:

- Electrical Equipment (Safety) Regulations 2016
- Restriction of the Use of Certain Hazardous Substances in Electrical and Electronic Equipment Regulations 2012 (SI 2012/3032)
- REACH ETC. (Amendment etc.) Regulations 2020 - SVHC

3 DIMENSIONS

EN

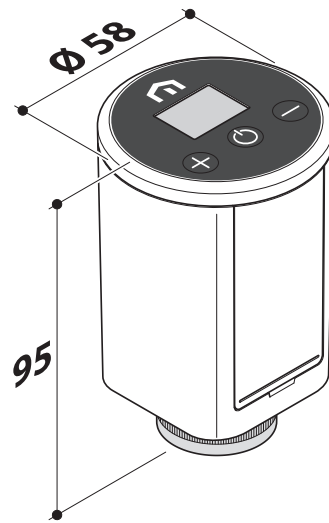

4 PACK CONTENTS

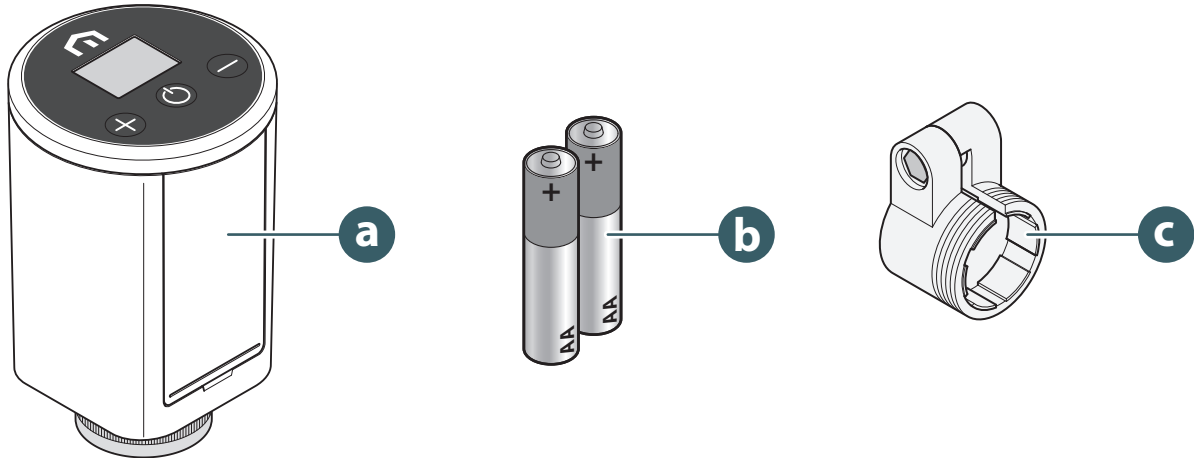



- a. Unisenza Plus Electronic Thermostatic Head
- b. 2 x AA-sized Alkaline Batteries
- c. RA Adapter



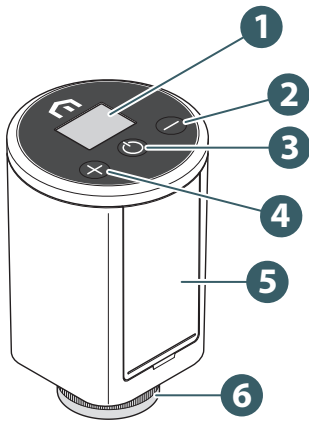







5 OVERVIEW

Unisenza Plus Electronic Thermostatic Head



1. Display LCD
2.  Button
3.  Button
4.  Button
5. Battery compartment
6. Securing ring

Display icons

Icon	Meaning	Description
	Antenna	On: the device is joined to a Unisenza Plus network Flashing: the device is searching for a Unisenza Plus network
	Pairing status	On: the device pairs with a room thermostat or a receiver Flashing: the device is in a pairing process
	Heating On	On: the device demands for Heat and the valve is opened by the Electronic Thermostatic Head actuator Flashing: the actuator motor is moving to adjust the valve opening
	Schedule mode	Schedule mode is running
	Off mode	Device is in Off mode, frost protection will be running.
	Battery icon	Shows the battery level
	Digits	Showing set point * or other information
	Key lock	Key is locked
	Alert	It is shown with an error code tell what system fault
	Temperature unit	Temperature unit in Celsius or Fahrenheit

(*) Display of room temperature option can be provided in the advanced settings on the App.

Button usage













When LCD backlight is Off

Turn on the LCD backlight

Press any buttons

When LCD backlight is On

Change mode (Off → Manual > Schedule)	Press 
Increase set point	Press 
Decrease set point	Press 
Fast increase set point	Press and hold 
Fast decrease set point	Press and hold 
Key lock or unlock	Press and hold  and 
Confirm set point	Press  , or wait for 3 seconds timeout after a new set point is set
Join network (if no network is joined before)	Press and hold 
Initiate pairing menu (if already joined a network)	Press and hold 
Factory reset	Press and hold  more than 10 seconds



No buttons can be used when the Extremely low battery icon appears.

6 DOWNLOAD THE APP



The management of the **Unisenza Plus Electronic Thermostatic Head** is also possible through a dedicated APP that allows its configuration and the management of the devices you will pair.

In order to download the **APP**, you need to connect to the **STORE** of your device used for configuration and install the **Unisenza Plus**.

Or, again using the device, you can directly access the installation page using the following **QR codes**, again depending on the operating system.

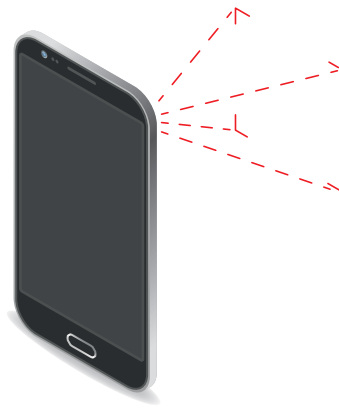
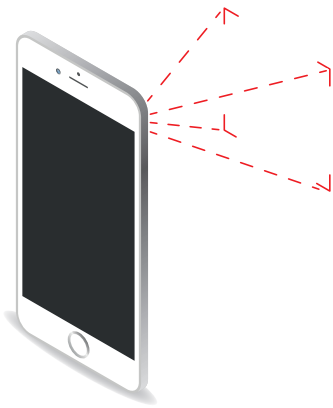

7 NAMEPLATE

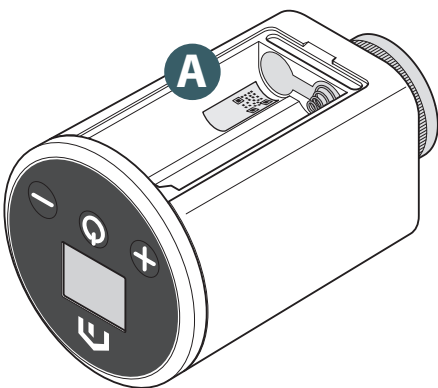

Inside the battery housing of the **Unisenza Plus Electronic Thermostatic Head** there is a sticker (**A**) which indicates the device data.

QR code availability for future feature.

8 INSTALLATION

EN

Recommendations for a correct installation

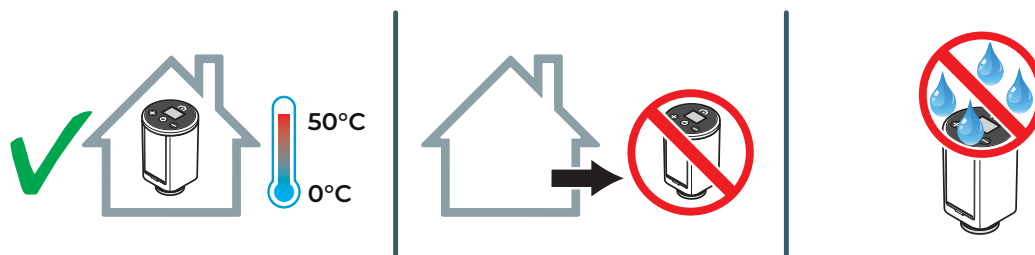

Heating system compatibility

The Unisenza Plus Electronic Thermostatic Head is compatible with the majority of thermostatic radiator valves.

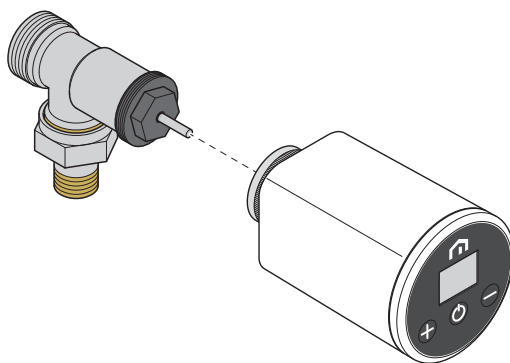

When mounting the **Unisenza Plus Electronic Thermostatic Head** on the **Danfoss RA** valve, please use the **RA adapter** as shown in below picture.

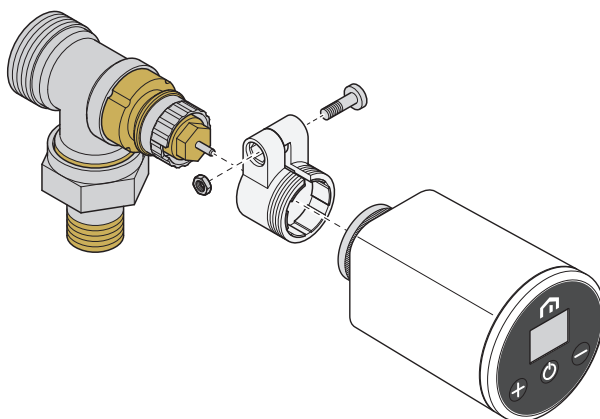

Inserting the batteries

The Unisenza Plus Electronic Thermostatic Head, to work, requires 2 AA alkaline batteries (included in the package).



Use only and exclusively the batteries indicated by the manufacturer in the table in the "Technical data" chapter.



When installing the batteries, observe the correct polarity indicated in the battery housing. Reversing the polarity runs the risk of damaging the electronic regulator.

To insert the batteries proceed as shown.

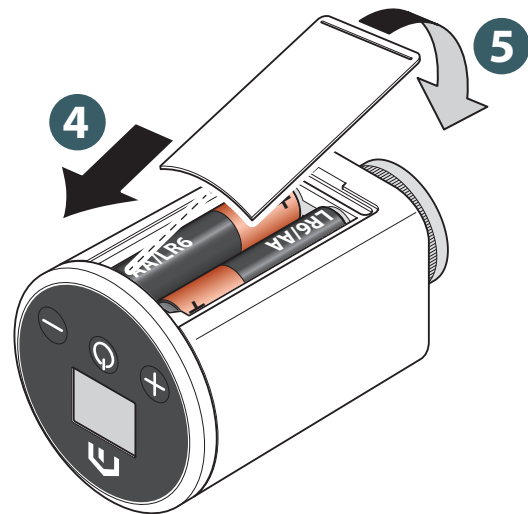
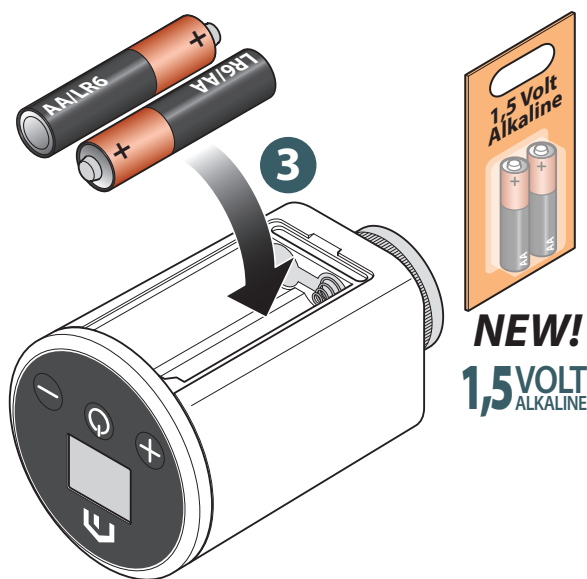
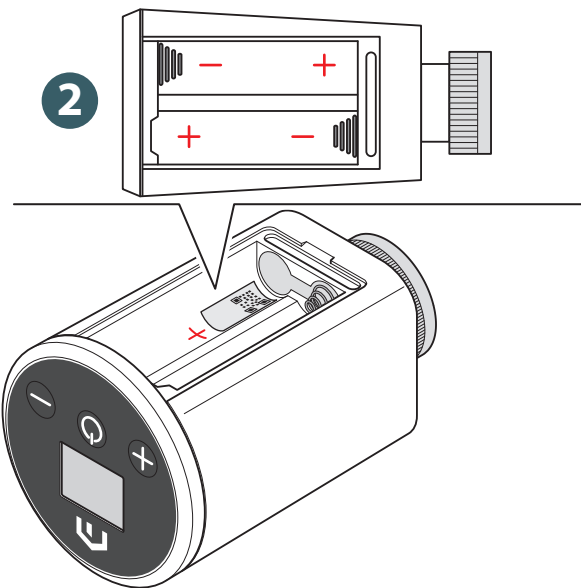
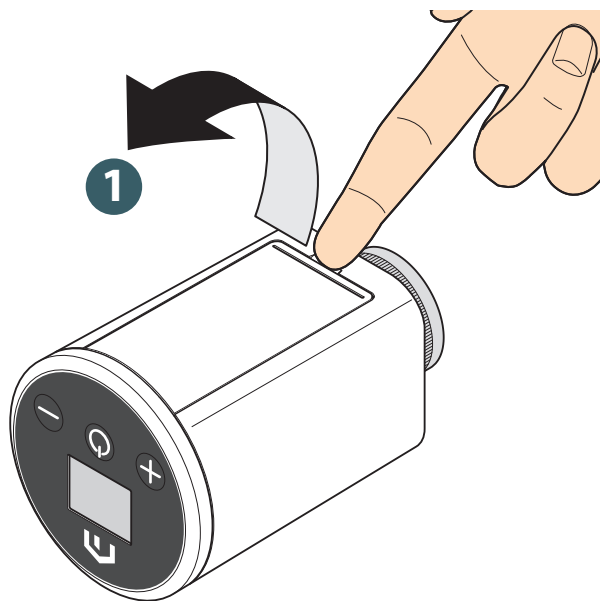

Installation on standard valve

To mount the Unisenza Plus Electronic Thermostatic Head on a standard valve proceed as shown.

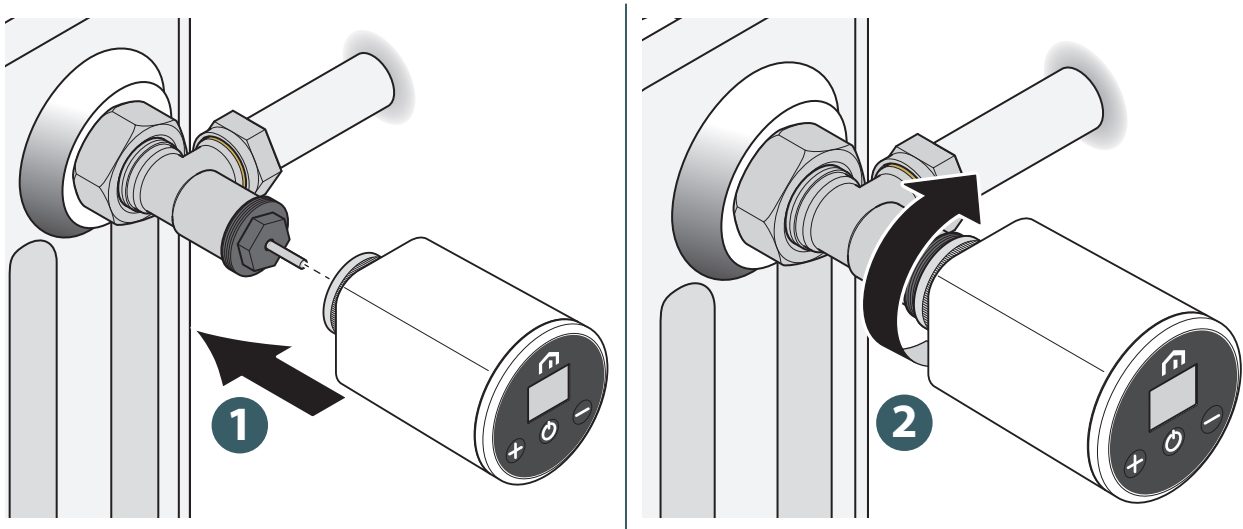

During assembly, be very careful not to use too much force in tightening the various components.



During assembly, if any problems arise, contact the Manufacturer and request assistance.

Installation on Danfoss RA valve

To mount the Unisenza Plus Electronic Thermostatic Head on a Danfoss RA valve proceed as shown.

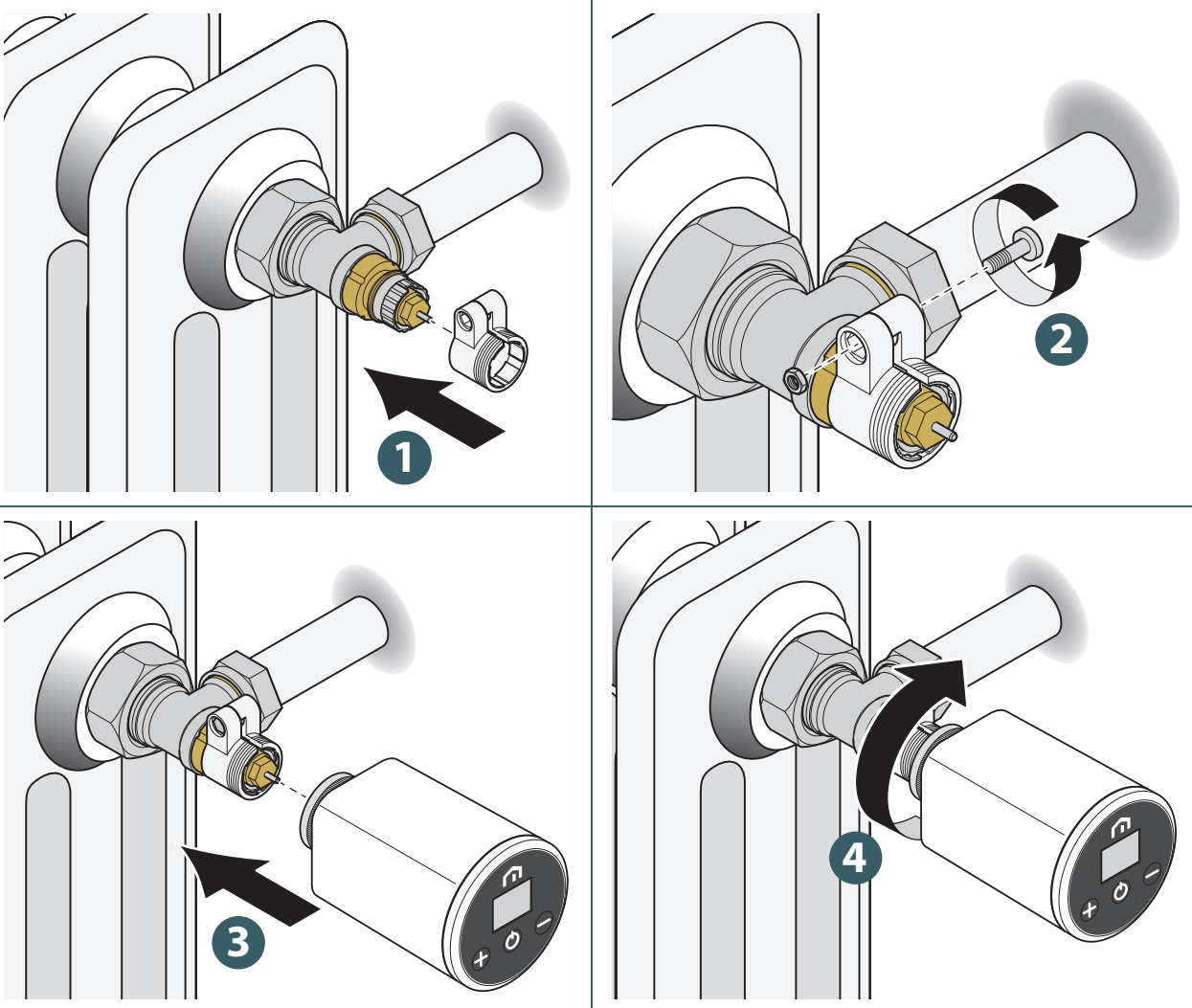

During assembly, be very careful not to use too much force in tightening the various components.



During assembly, if any problems arise, contact the Manufacturer and request assistance.

9 USE

Main screen operation



The LCD backlight is Off during stand by in normal operation. Press any key to turn on the LCD backlight before performing other user operations as described below. The LCD backlight will be turned off automatically when no key press for 15 seconds.

When at extremely low battery,  is displayed and flashes. All buttons input is not allowed and the LCD backlight will not turn On. Therefore, below operations cannot be done.

Power up

The ignition of the **Unisenza Plus Electronic Thermostatic Head** takes place by inserting the batteries in their housing, which has already been seen in the previous chapters.

Below what appears on the display.

1 Display power up

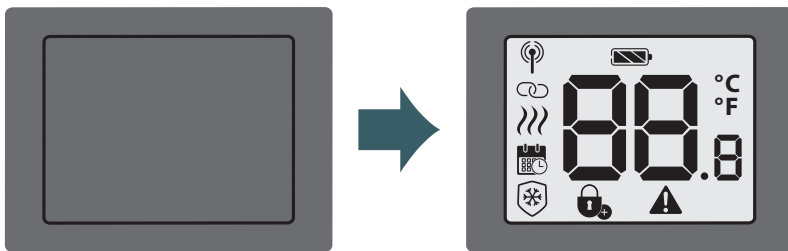

2 Firmware version installed



3 Preparation for installation

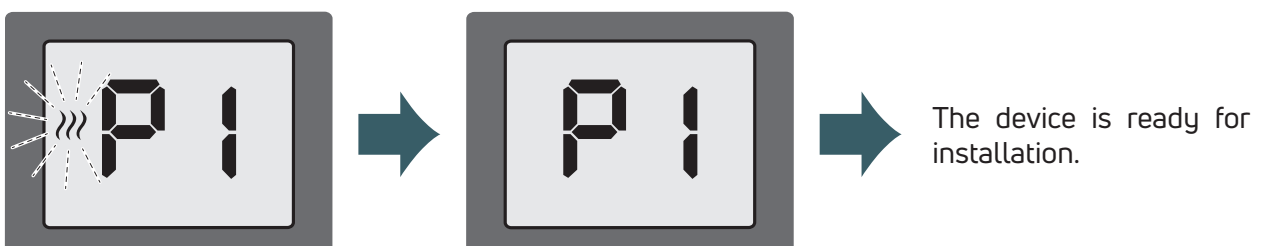

Joining to Unisenza Plus Gateway

With APP



The association between the **Unisenza Plus Electronic Thermostatic Head** and the **Unisenza Plus Gateway** can be done through the system management **APP**.

To proceed with the association you need to have already installed and configured the **Gateway**.

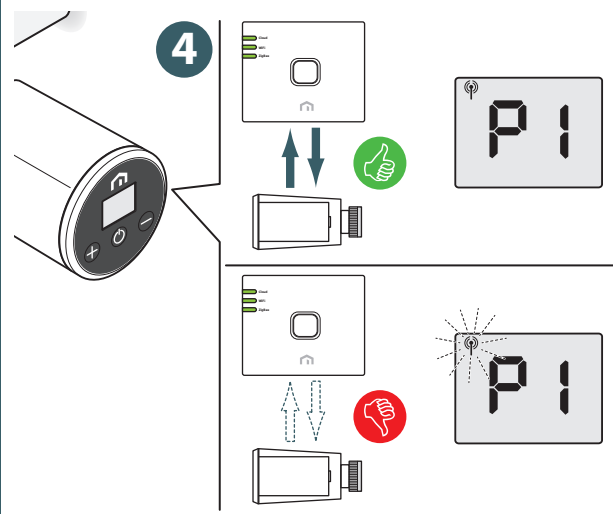
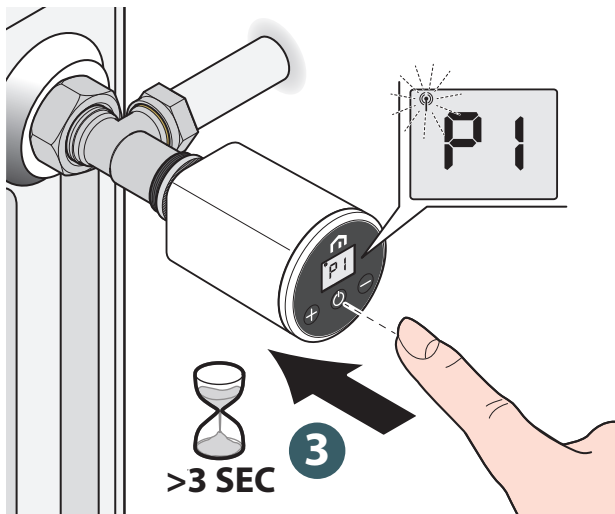
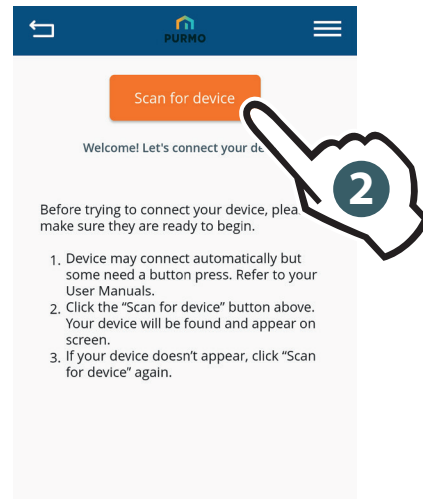
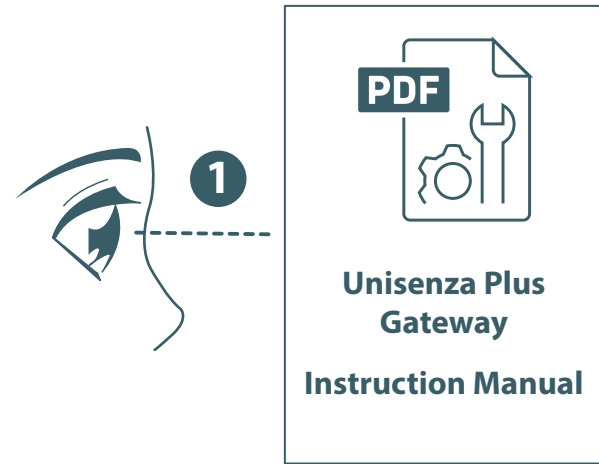

If you want to associate a **Unisenza Plus Electronic Thermostatic Head** that was previously associated with another Gateway, it is necessary to perform a reset to the factory settings of the electronic regulator before making the new association.

Without APP



The association between the **Unisenza Plus Electronic Thermostatic Head** and the **Unisenza Plus Gateway** can also be made directly between the two devices.

To proceed with the association you need to have already installed and configured the **Gateway**.

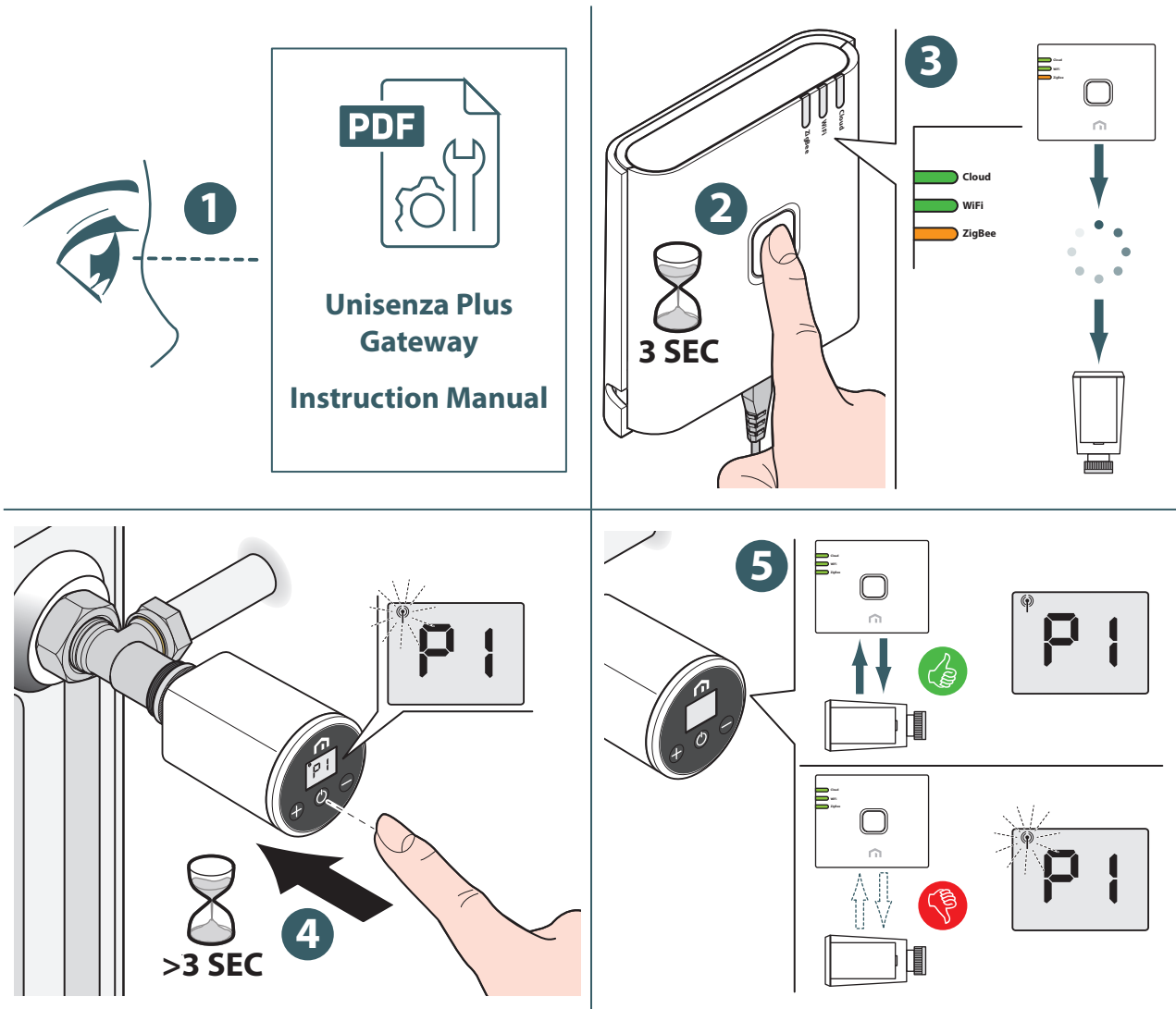

If you want to associate a **Unisenza Plus Electronic Thermostatic Head** that was previously associated with another **Gateway**, it is necessary to perform a **reset to the factory settings** of the electronic regulator before making the new association.

Valve calibration

When the **Unisenza Plus Electronic Thermostatic Head** is firstly installed to the radiator valve, follow below step to perform the valve adaptation.

To carry out the procedure, proceed as indicated in the following images.

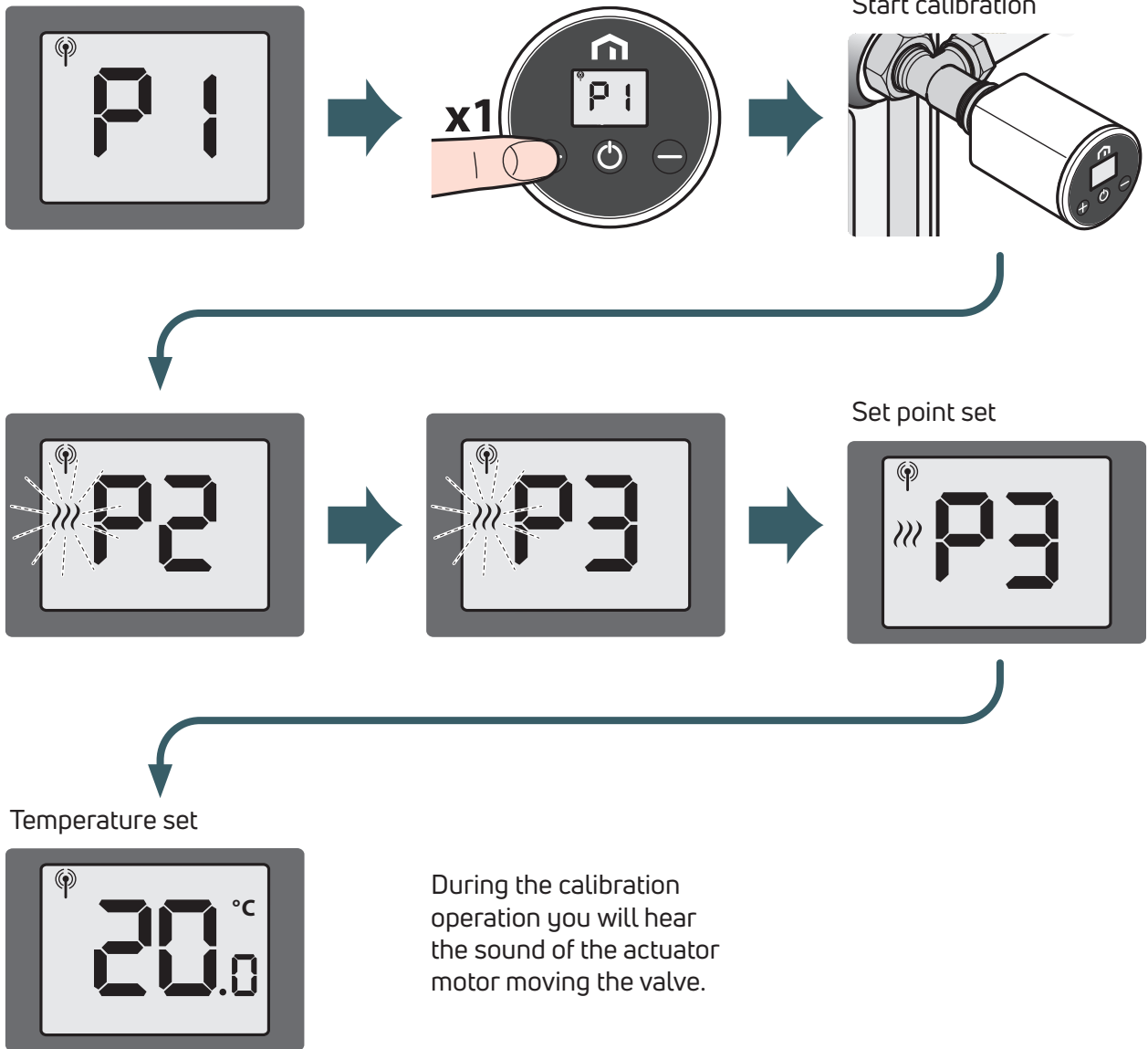

If an error occurs during the adaptation process, the LCD display will show the error code A03. To carry out the procedure again, it is necessary to perform a Power Reset by removing and reinstalling the batteries.

Pairing with other Unisenza Plus device (optional)

After the Unisenza Plus Electronic Thermostatic Head joined a ZigBee network, it can be paired with a Unisenza Plus Receiver or Unisenza Plus Thermostat.

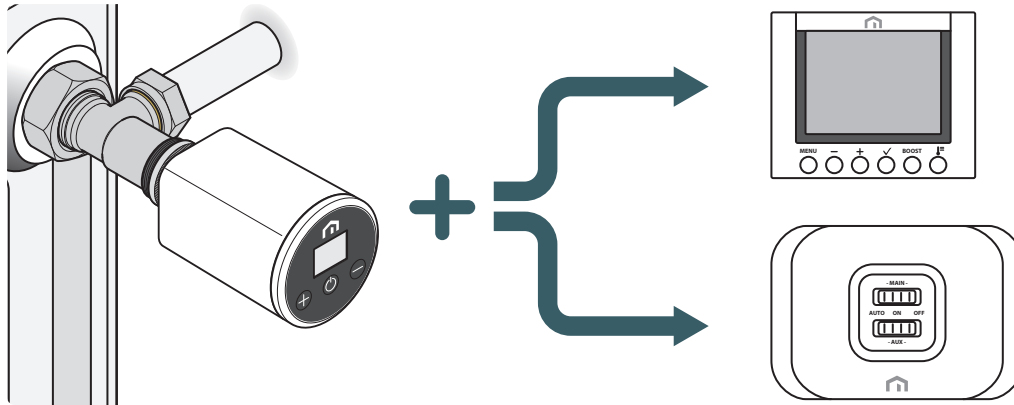

When pair with a receiver, the Unisenza Plus Electronic Thermostatic Head heat demand will be passed to the receiver to interlock the boiler or the zone valve.

When pair with a room thermostat, the thermostat will become a remote control to the Unisenza Plus Electronic Thermostatic Head. The room temperature measured by the thermostat will be used by the Unisenza Plus Electronic Thermostatic Head.

The Unisenza Plus Electronic Thermostatic Head displays , and the set point and mode control will follow the settings on the room thermostat.

A maximum of 6 Unisenza Plus Electronic Thermostatic Head can be paired with a room thermostat.

When the Unisenza Plus Electronic Thermostatic Head is paired with a room thermostat, the boiler interlock with the Unisenza Plus Receiver for the heat demand can be done via the thermostat.

A maximum of total 16 Unisenza Plus Electronic Thermostatic Head or Unisenza Plus Thermostat can be paired with Unisenza Plus Receiver.

Pair and unpair device using App



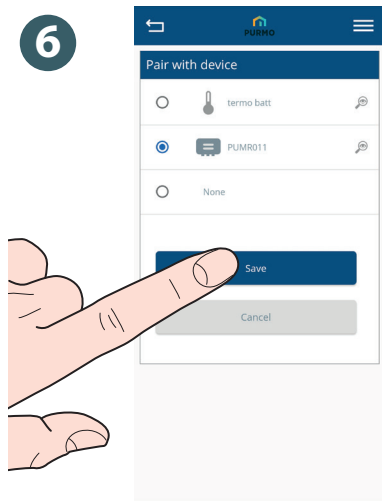
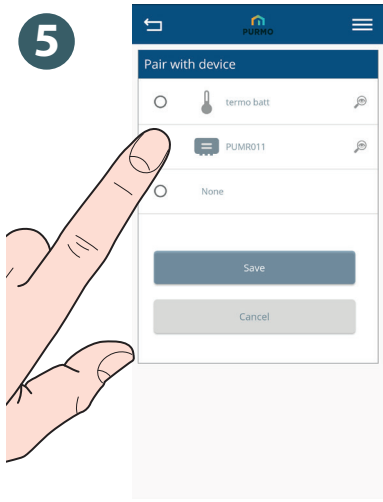
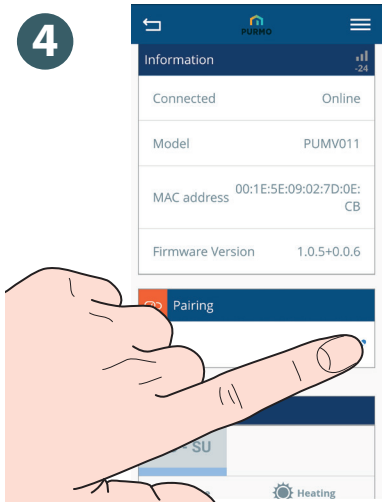

Pair device using the Unisenza Plus Electronic Thermostatic Head local interface

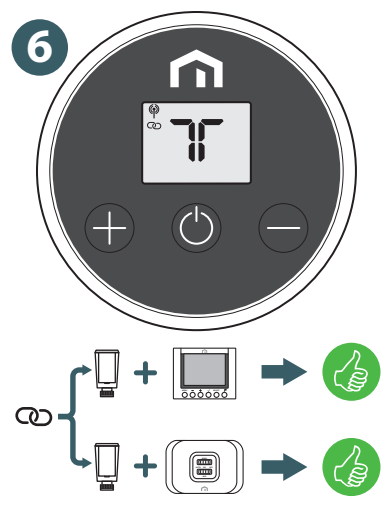
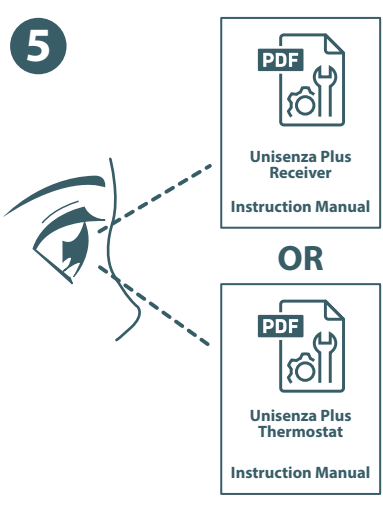
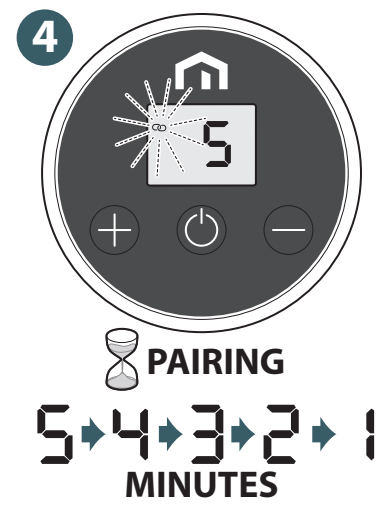
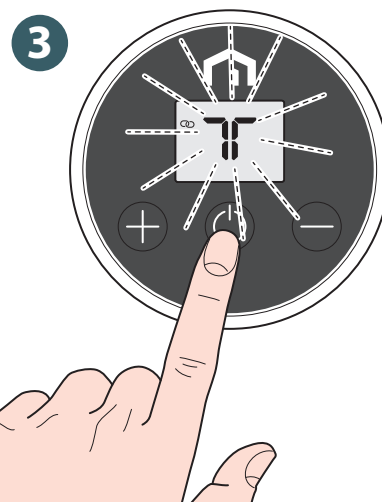
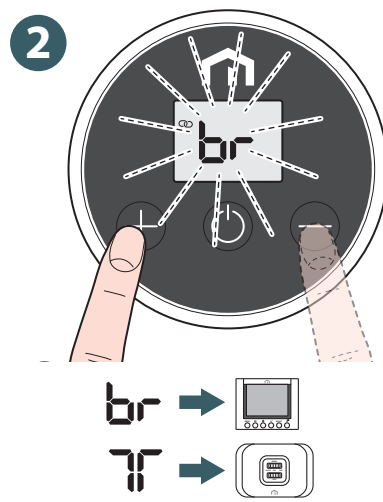



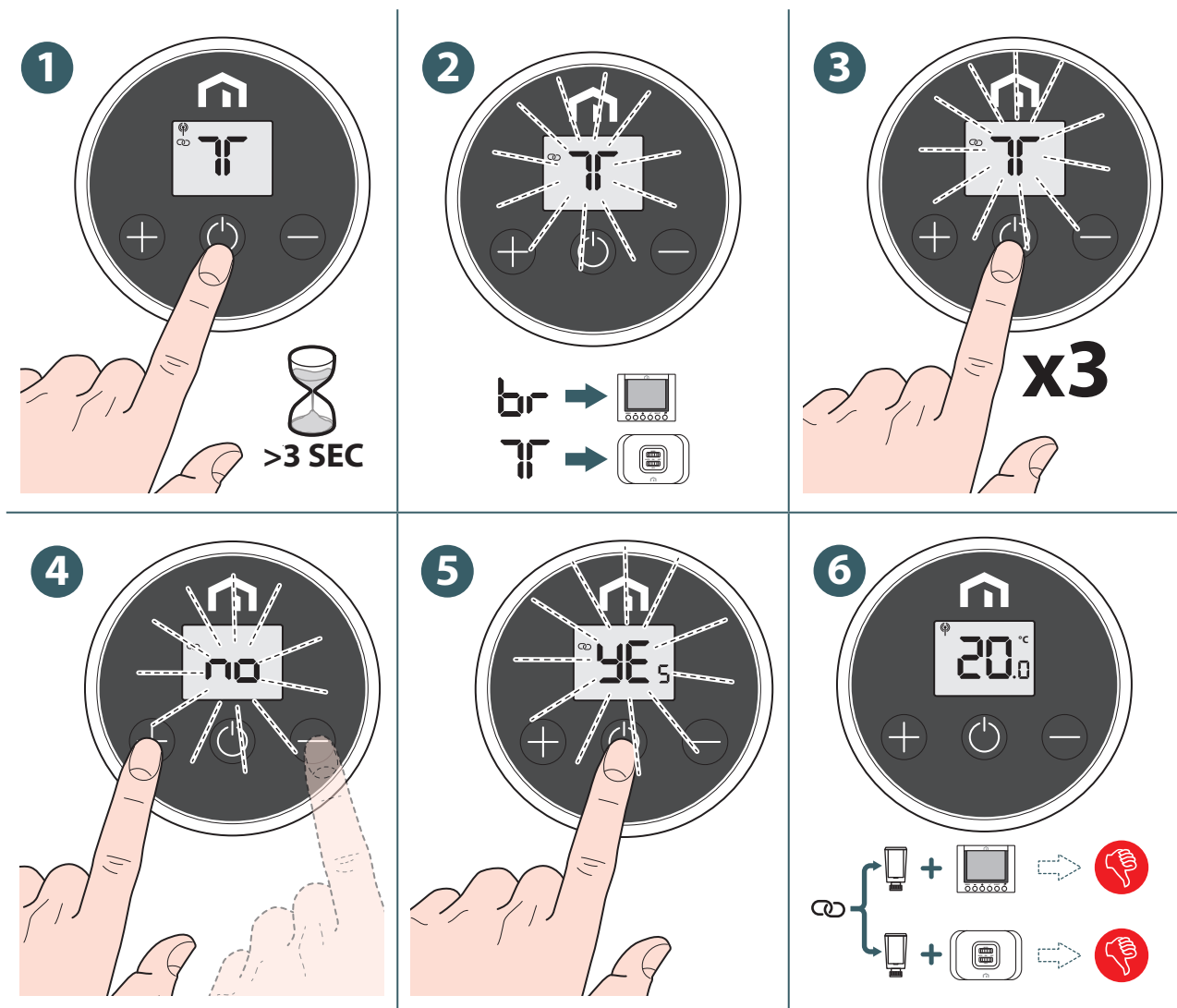

Unpair device using the Unisenza Plus Electronic Thermostatic Head local interface



Change operation mode

The Unisenza Plus Electronic Thermostatic Head has three operating modes.

Press  to change one of the following operation mode. During mode change, the LCD displays and flashes the mode indication.

Icon	Mode	Explanation
	Schedule mode	The device operates according to the schedule defined in the App.
	Off mode	The device is turned Off with frost protection active.
	Manual mode	The device operates according to the manual input of set point

After selected the operation mode, press  or wait for **3 seconds** timeout to confirm new mode is changed. The Unisenza Plus Electronic Thermostatic Head display then returns to normal.

Change set point in Manual mode

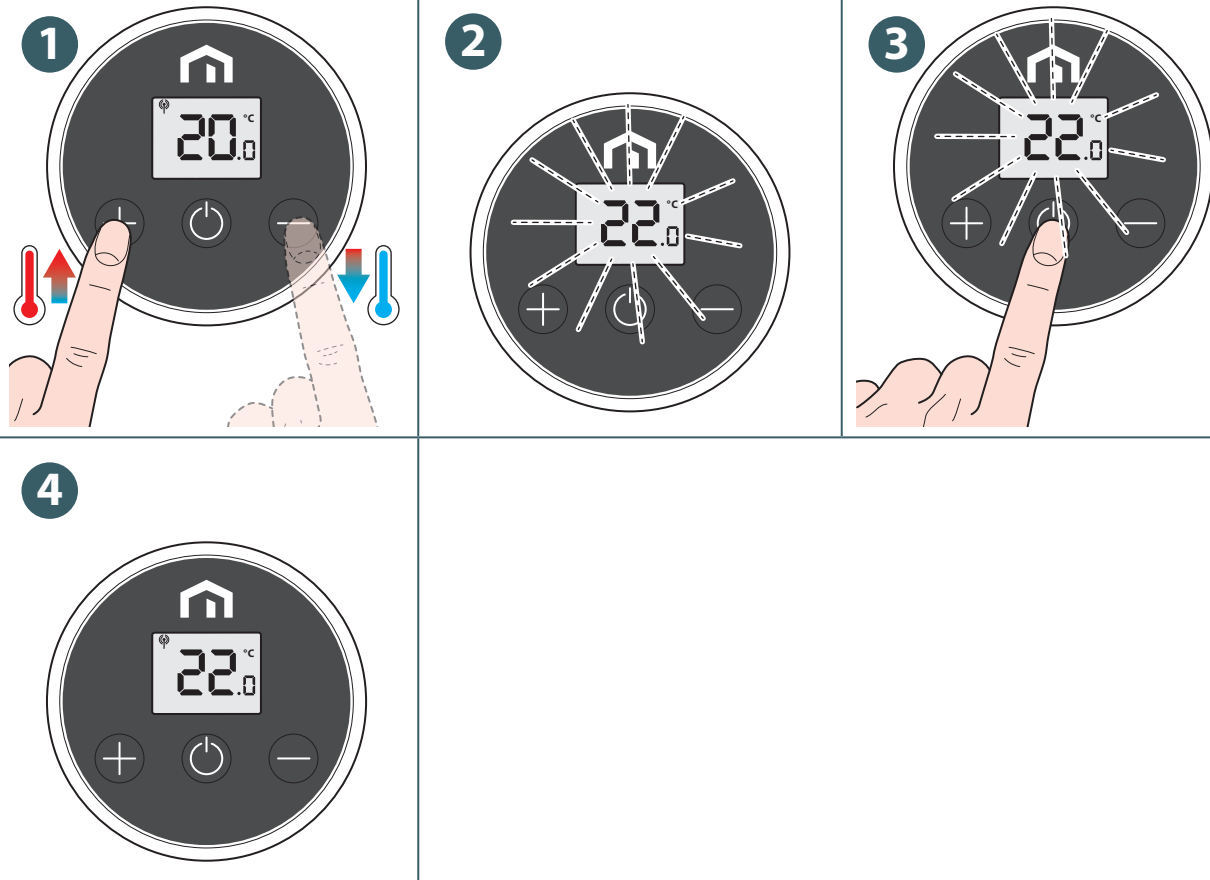

Temporarily change set point in Schedule mode

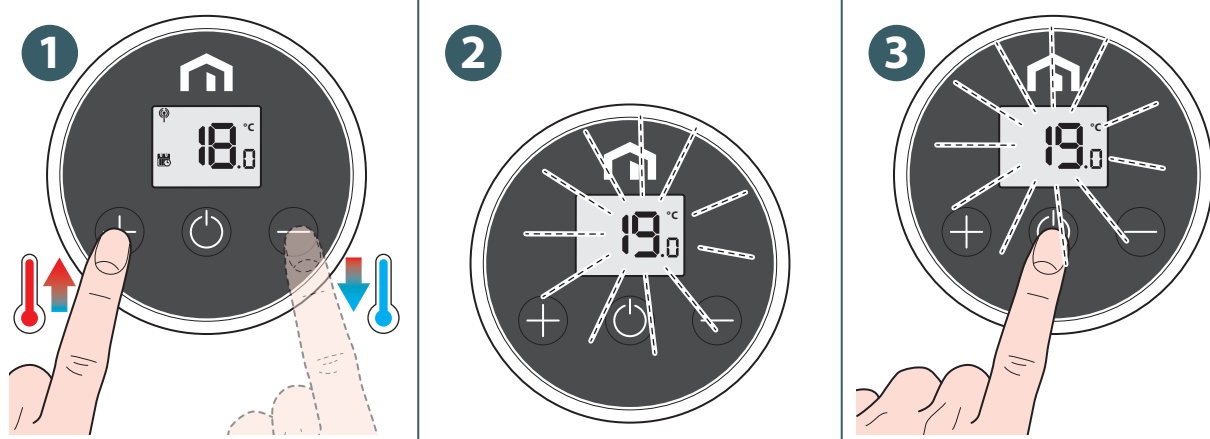

This new **set point** replaces the **planning set point** temperature and will remain active until the next planning time slot arrives. Subsequently the temperature will be the one established according to the planning on the APP.



The  icon is displayed continuously when temporarily change to set point.

Off mode with frost protection

When change to **Off mode**, the  icon is displayed and the frost protection is active. The **Unisenza Plus Electronic Thermostatic Head** actuator will open and close the valve occasionally when the room temperature drops **below 5° C** in order to avoid the pipe from freezing.

Window open mode

The **Unisenza Plus Electronic Thermostatic Head** can detect a sudden drop of room temperature, which is possibly caused by the opening of windows nearby. In this situation, the heating system may not be able to maintain the room temperature and thus it should be turned Off to save energy.

When the **Unisenza Plus Electronic Thermostatic Head** operates (except for in Off mode) and it detects a sudden drop of temperature, the device enters **Window Open mode**. In this mode, the LCD display shows  and the actuator will move to close the valve.

This mode ends when the room temperature increases or this mode runs for **30 minutes**.

This mode can also be ended manually by pressing  to change back to normal operation.

Valve protection

If the valve is not opened or closed for a long time may cause scale deposits that may block the valve from moving.

The **Unisenza Plus Electronic Thermostatic Head** has a protection function to fully open or close the valve automatically once **every 14 days** if no valve movement is detected.

Alert / Error code

When there is fault or alert, the LCD displays  icon and the error code (with prefix "A", eg. **AO₂**) on the display.

When more than one alert, the error code is shown one by one. This alert screen and the current operation screen is displayed alternatively.

Error code	Description
AO₁	Lost link with Gateway.
AO₂	Lost link with any paired device, either the thermostat or the receiver.
AO₃	Adaptation error.

10 MAINTENANCE

Low battery

When the **Unisenza Plus Electronic Thermostatic Head** detects low battery,  is displayed. Battery should be replaced as soon as possible.

When battery is at extremely low level,  is displayed and flashes.

All buttons input is not available and the actuator motor adjusts the valve at fully open position.



Replace with new batteries and go through the calibration process to resume normal operations.

Over-the-air (OTA) software update operation

The **Unisenza Plus Electronic Thermostatic Head** upgrades its software automatically when there is a newer version software available from the server.

A valid connection to the gateway and the Internet is needed to allow the **Unisenza Plus Electronic Thermostatic Head** to download the new software image. All device functionality is maintained during the download and the update process, until the device restarts to update the new software. During the update process, the LCD displays the status on the digit with animation. A full digit "0" is displayed after finishing the update.

All settings and paired devices information are retained after the update.

Factory reset

The **Unisenza Plus Electronic Thermostatic Head** can be factory reset, all settings including valve calibration, joined Unisenza Plus network and paired Unisenza Plus device information is reset to factory default.

To restore the device to factory settings, carry out the following operations:

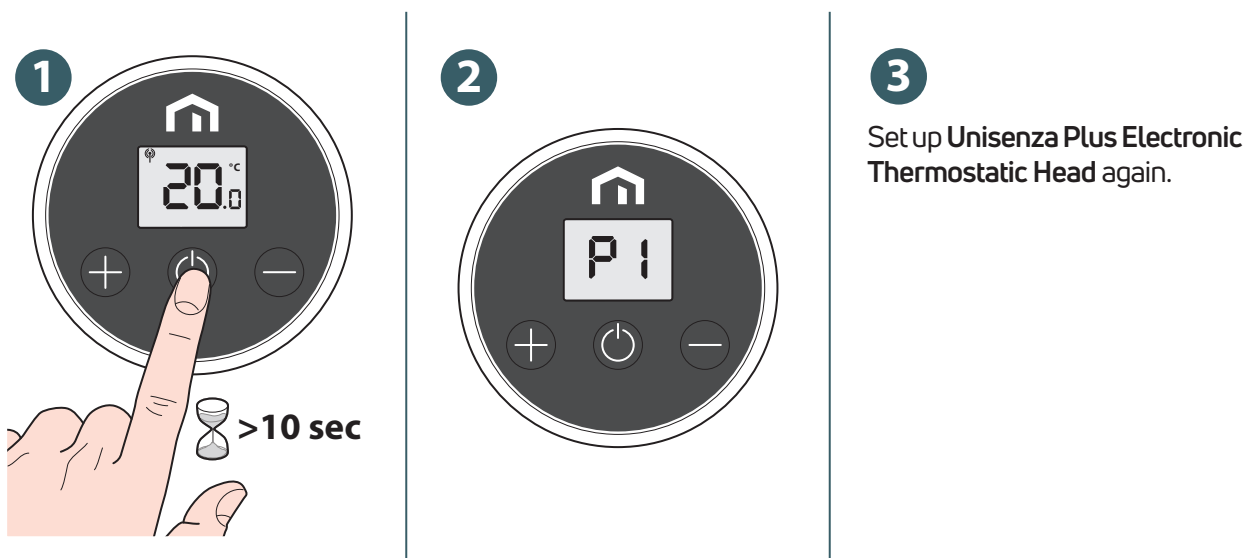

Cleaning



11 MANUAL DOWNLOAD AND UPDATES

Due to the requirement for continuous improvement, we constantly update the user manuals of our systems.

We therefore invite you to periodically check whether the manual in your possession is always the latest written version.

To do this, you can connect to the following **internet address**:

<https://www.purmogroup.com/support>

or by scan the **QR code** displayed below.



12 DISPOSAL AT THE END OF LIFE



Pursuant to art. 13 of Decree-Law No. 49 of 2014 "Implementation of the WEEE Directive 2012/19/EU on waste electrical and electronic equipment".

The mark of the crossed-out bin with a bar specifies that the product was placed on the market after 13 August 2005 and that at the end of its useful life it must not be collected with other waste but must be disposed of separately. All the appliances are made of recyclable metal materials (stainless steel, iron, aluminium, galvanized sheet metal, copper, etc.) in a percentage greater than 90% by weight. Make the equipment unusable for disposal by removing the power cable and any compartment or cavity closing device (if any). It is necessary to pay attention to the management of this product at the end of its life by reducing any negative impacts on the environment and improving the efficiency of the use of resources, applying the principles of "polluter pays", prevention, preparation for reuse, recycling and recovery. Please note that the illegal or incorrect disposal of the product entails the application of the penalties provided for by current legislation.

Information on disposal in Italy

In Italy **WEEE** equipment must be delivered to:

collection centres (also called waste separation areas or platforms)

the Dealer where you buy new equipment, who is required to accept it free of charge ("one on one" collection).

Information on disposal in European Union countries

The EU **WEEE** equipment directive has been adopted differently by each country, therefore if you want to dispose of this equipment we suggest you contact the local authorities or the dealer to ask for the correct method of disposal.

A PURMO GROUP BRAND 

Bulevardi 46
P.O. Box 115
FI-00121 Helsinki
Finland
www.purmogroup.com

Every care has been taken in the creation of this document. No part of this document may be reproduced without the express written consent of Purmo Group. Purmo Group accepts no responsibility for any inaccuracies or consequences arising from the use or misuse of the information contained herein.

