



WALLMOUNT

The wallmount range provides rapid heat using a small amount of space. They are perfect for maximising the amount of available space in any room. They provide solutions for semi-commercial applications such as retail or restaurant dining spaces. They can also be a great solution for domestic properties in areas such as conservatories or narrow areas that have large heating demands.

HI-LINE Range

MYSON HI-LINE is a range of high level, wall mounted fan convectors that can utilise unused space above a door. They provide rapid heat from above and incorporate technology that is generations ahead of the competition. HI-LINE connects easily to a central heating system.

- Range includes the discreet HI-LINE RC, the powerful HI-LINE SUPER RC and a low voltage 12V model
- Perfect for domestic and commercial applications, such as restaurants and offices
- HI-LINE RC and HI-LINE SUPER RC are fitted with digital controls and supplied with a handheld remote
- HI-LINE LV model is ideally suited to bathroom applications where safety matters most

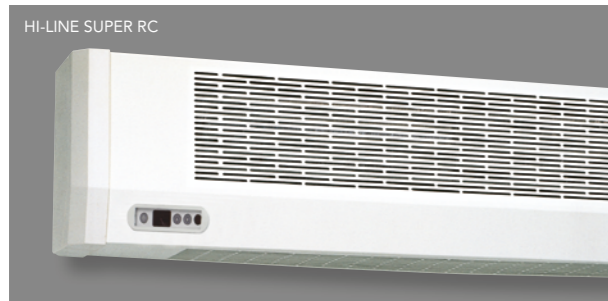

LO-LINE RC

SLIM-LINE RC

LO-LINE RC

MYSON LO-LINE RC is a low level, wall mounted fan convector that delivers high heat outputs, quickly. Ideal for areas such as conservatories, which feature limited wall space and require instant warmth during occasional use. Easily connects to an existing central heating system.

- Available in four sizes that increase in performance
- Fitted with digital controls and supplied with a handheld remote control





SLIM-LINE RC







Designed to fit within any narrow space, the SLIM-LINE RC is a vertical, wall mounted fan convector that utilises small spaces but without compromising on heat outputs.

- Compact design slots onto a pillar or within an alcove
- Fitted with digital controls and supplied with a handheld remote control

WALLMOUNT RANGE (HI-LINE, LO-LINE, SLIM-LINE)

GENERAL SPECIFICATION

-  **CERTIFICATION**
Produced under a quality management system - ISO 9001:2015, environmental management system - ISO 14001:2015 and Occupational health and safety management system - ISO 45001:2018. Carries the CE mark and conforms to the Low Voltage Directive 2014/35/EU and the EMC Directive 2014/30/EU. Outputs are tested to BS 4856 Part 1. Sound levels are tested to EN 23741.
-  **GUARANTEE**
2 year guarantee from date of purchase against manufacturing defects.
-  **COLOUR**
Finished in white (RAL 9016) powder coating.
-  **ANTI-BACTERIAL PAINT**
Coating to suppress bacterial growth.
-  **SYSTEM**
Closed circulation, 2 pipe pump assisted central heating systems.

-  **CONNECTIONS**
15mm copper pipe (HI-LINE RC, LO-LINE RC and SLIM-LINE RC), 22mm copper pipe (HI-LINE SUPER RC).
-  **AIR VENTS**
Integrated with LO-LINE RC and SLIM-LINE RC. Excluded from HI-LINE range.
-  **OPERATING PRESSURES**
Tested to a pressure of 20 bar. Working pressure of up to 10 bar.
-  **OPERATING TEMPERATURE**
Maximum 90°C.
-  **ELECTRICAL SUPPLY**
220-240V - 50Hz fused at 3A.
-  **DELIVERY**
2 - 5 working days.

For more general information, please see page 276.

CONTROLS

HI-LINE RC, HI-LINE SUPER RC, LO-LINE RC and SLIM-LINE RC units are supplied with an electronic infra-red remote control system with the following features:

- Automatic room temperature control
- Fan only option for ambient air circulation
- Three fan speeds
- Unit mounted controls and display
- Unit control panel electronic tamper proof lock
- Displayed temperature calibration system

HI-LINE LV units are fitted with a switch offering high and low fan speeds and off selection. A low limit thermostat is fitted to the unit to ensure that the fan stops after the heating system is switched off.



REMOTE CONTROL SUPPLIED (Excluding LV Model)



CONTROL PANEL (Excluding LV Model)

WALLMOUNT RANGE (HI-LINE, LO-LINE, SLIM-LINE)

TECHNICAL INFORMATION

HI-LINE RC, HI-LINE LV DIMENSIONS & FIXINGS

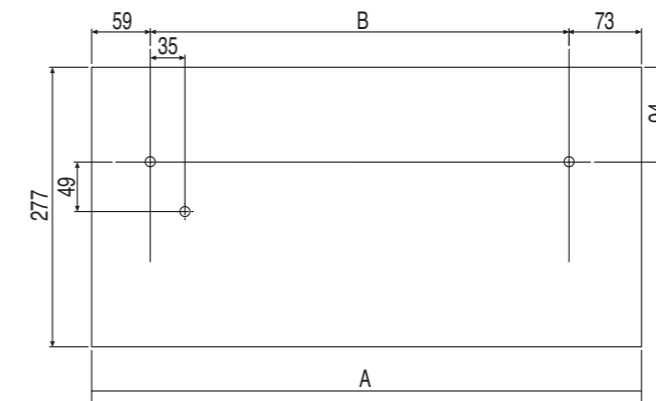

Model	A	B
	(mm)	(mm)
7-4*	554	422
10-6	682	550
15-10	886	754
20-14	1171	1039

*HI-LINE LV only available as a 7-4 model

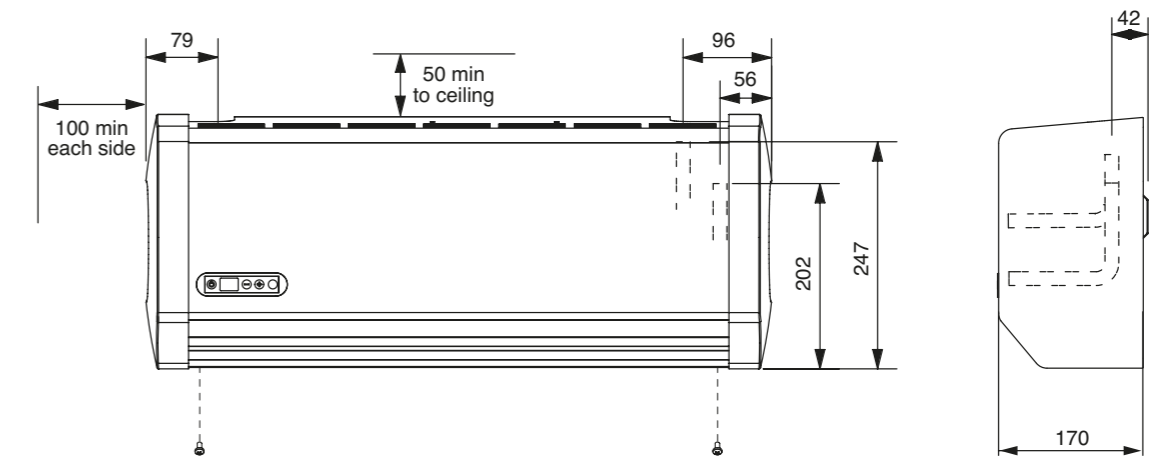

Case fixing screw positions and water connections

- Maximum installation height is 2.13m to the underside of the unit
- Minimum installation height is 1.8m to the underside of the unit
- Maximum ceiling height is 3m
- Minimum clearance each side is 100mm
- Minimum top clearance is 50mm
- Please note the transformer is mounted inside the unit (LV model only)

If installing the product above the recommended height consider adding additional margin to the heat loss, or install de-stratification fans.

WALLMOUNT RANGE (HI-LINE, LO-LINE, SLIM-LINE)

TECHNICAL INFORMATION (cont...)

HI-LINE SUPER RC DIMENSIONS & FIXINGS

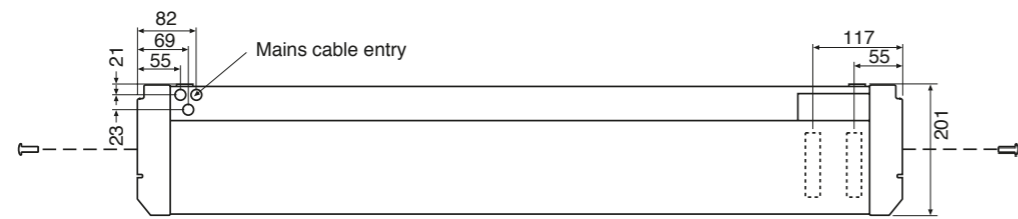
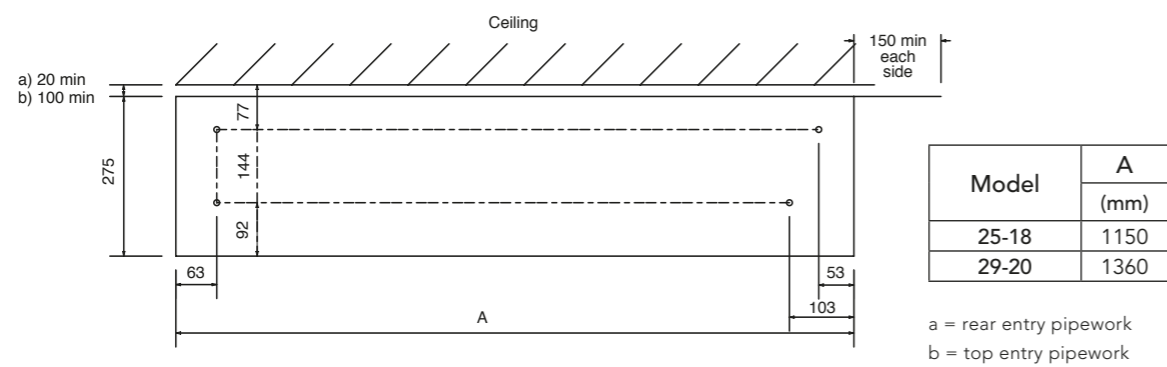

Case fixing screw positions and water connections

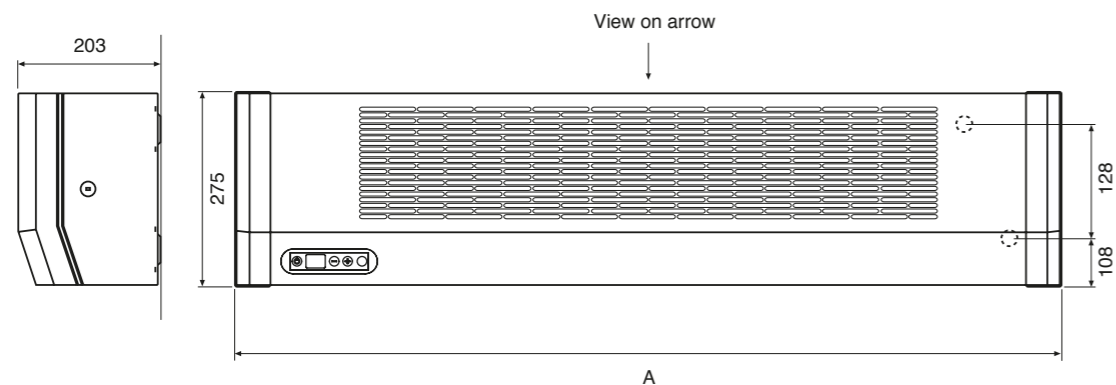

Model	A (mm)
25-18	1168
29-20	1378

- Maximum installation height is 3m to the underside of the unit
- Minimum installation height is 1.8m to the underside of the unit
- Maximum ceiling height is 3.5m

- Minimum side clearance is 150mm

If installing the product above the recommended height consider adding additional margin to the heat loss, or install de-stratification fans.

LO-LINE RC DIMENSIONS & FIXINGS

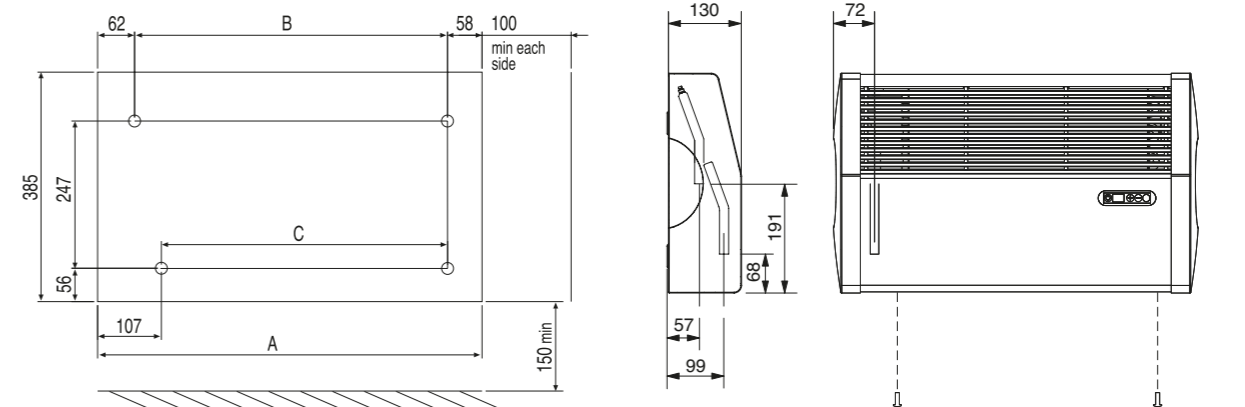

Case fixing screw positions and water connections

Model	A (mm)	B (mm)	C (mm)
6-4	523	404	359
9-6	645	526	481
14-10	854	733	681
19-15	1138	1018	974

- Minimum installation height is 150mm to the underside of the unit
- Minimum clearance each side is 100mm

SLIM-LINE RC DIMENSIONS & FIXINGS

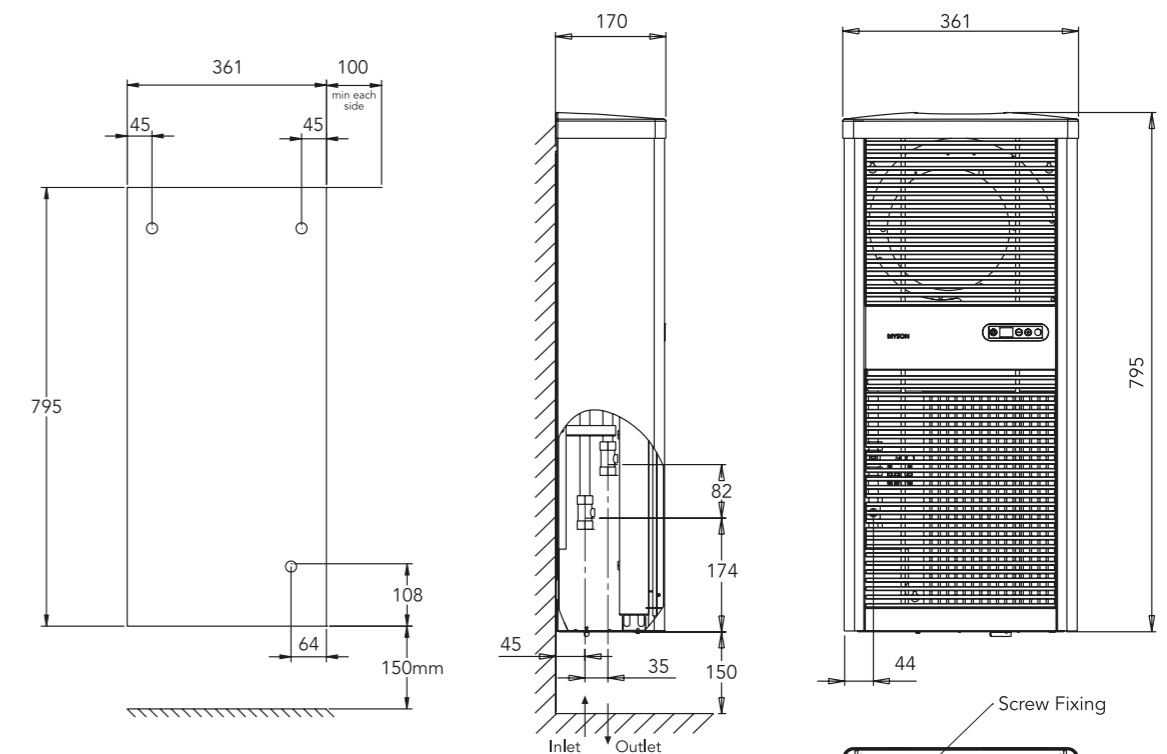

Case fixing screw positions and water connections

- Minimum installation height is 150mm to the underside of the unit
- Minimum clearance each side is 100mm

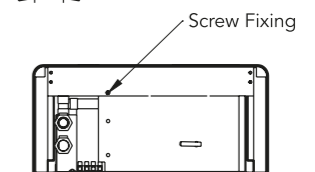

WALLMOUNT RANGE (HI-LINE, LO-LINE, SLIM-LINE)

TECHNICAL INFORMATION (cont...)

		Fan Speed	Model						
			HI-LINE RC				HI-LINE SUPER RC		HI-LINE LV
			7-4	10-6	15-10	20-14	25-18	29-20	7-4
Dimensions	Nominal Height (mm)	-	277	277	277	277	275	275	277
	Nominal Depth (mm)	-	170	170	170	170	203	203	170
	Nominal Length (mm)	-	554	682	887	1171	1150	1360	554
Sound Levels*	Sound Pressure (dBA) (at 2.5m)	Normal	23.4	23.5	28.8	33.3	28.3	33.7	16.6
		Medium	32.5	30.8	35.4	38.7	37.8	36.8	-
		Boost	43.3	37.2	45.6	45.4	45.6	47.9	32.5
Weight, Water Content & Motor Power	Unpacked Weight (kg)	-	7.4	8.9	11.3	14.7	18.0	21.0	7.4
	Water Content (l)	-	0.30	0.32	0.56	0.77	0.63	0.85	0.3
	Motor Power (W - max.)	-	35	35	62	80	80	80	30
Air Flow Rates	Air Flow (m³/h)	Normal	81	143	207	285	350	390	81
		Medium	105	171	276	371	430	470	-
		Boost	133	220	333	431	500	540	133
	Air Flow (ft³/h)	Normal	2859	5048	7307	10061	12360	13772	2859
		Medium	3707	6036	9743	13096	15185	16597	-
		Boost	4695	7766	11755	15214	17657	19069	4695

		ltr/h	Model							
			HI-LINE RC				HI-LINE SUPER RC		HI-LINE LV	
			7-4	10-6	15-10	20-14	25-18	29-20	7-4	
Approximate Hydraulic Resistance	mm wg	455	1084	1240	1500	1774	2095	2551	1084	
		341	798	657	905	1140	1282	1530	798	
		227	350	327	450	565	620	850	350	
	kPa	113	134	105	157	221	234	245	134	
		341	9.4	12.12	14.7	17.42	20.5	24.6	9.4	
		227	7.7	6.42	8.9	11.2	12.6	15.0	7.7	
		113	3.5	3.25	4.37	5.5	6.1	8.3	3.5	
			113	1.4	1.1	1.57	2.1	2.3	2.4	1.4

*Sound levels tested in accordance with EN 23741.

		Fan Speed	Model				
			LO-LINE RC				SLIM-LINE RC
			6-4	9-6	14-10	19-15	
Dimensions	Nominal Height (mm)	-	385	385	385	385	795
	Nominal Depth (mm)	-	130	130	130	130	170
	Nominal Length (mm)	-	523	645	854	1138	361
Sound Levels*	Sound Pressure (dBA) (at 2.5m)	Normal	23.7	21.6	23.1	27.2	21.9
		Medium	31.7	29.6	28.5	31.8	30.6
		Boost	40.7	38	40.1	38.6	39.7
Weight, Water Content & Motor Power	Unpacked Weight (kg)	-	7.7	9.1	12.7	15.7	14.5
	Water Content (l)	-	0.3	0.32	0.56	0.75	0.51
	Motor Power (W - max.)	-	35	35	62	80	125
Air Flow Rates	Air Flow (m³/h)	Normal	65	112	160	241	164
		Medium	86	129	200	288	216
		Boost	122	175	288	335	316
	Air Flow (ft³/h)	Normal	2295	3954	5648	8507	5789
		Medium	3036	4554	7060	10166	7625
		Boost	4307	6178	10166	11826	11155

		ltr/h	Model					
			LO-LINE RC				SLIM-LINE RC	
			6-4	9-6	14-10	19-15		
Approximate Hydraulic Resistance	mm wg	455	910	998	1240	1670	1771	
		340	514	520	719	954	1161	
		227	235	121	324	469	561	
	kPa	113	47	97	75	77	201	
		340	8.98	9.85	12.20	16.40	17.4	
		227	5.06	5.10	7.00	9.40	11.4	
		113	2.35	1.18	3.20	4.60	5.5	
			113	0.45	0.97	0.75	0.82	2.0

*Sound levels tested in accordance with EN 23741.

WALLMOUNT RANGE (HI-LINE, LO-LINE, SLIM-LINE)

HEAT OUTPUTS

HI-LINE RC

Model	Fan Speed	Heat Outputs @ ΔT 50°C		Heat Outputs @ ΔT 30°C		Order Code
		Watts	Btu/h	Watts	Btu/h	
HI-LINE RC 7-4	Normal	930	3172	541	1845	HIRC7
	Medium	1292	4410	752	2565	
	Boost	1702	5808	991	3380	
HI-LINE RC 10-6	Normal	1610	5493	937	3197	HIRC10
	Medium	1959	6683	1140	3889	
	Boost	2521	8602	1467	5005	
HI-LINE RC 15-10	Normal	2459	8390	1431	4881	HIRC15
	Medium	2783	9496	1620	5526	
	Boost	3690	12590	2147	7327	
HI-LINE RC 20-14	Normal	3468	11831	2018	6884	HIRC20
	Medium	4380	14944	2548	8695	
	Boost	4959	16921	2889	9858	

HI-LINE SUPER RC

Model	Fan Speed	Watts	Btu/h	Watts	Btu/h	Order Code
		4270	14569	2563	8746	
5238	17873	3030	10339			
6200	21154	3454	11785			
HI-LINE SUPER RC 29-20	Normal	4962	16930	2870	9791	2HI29
	Medium	6011	20508	3462	11811	
	Boost	7045	24037	4040	13785	

HI-LINE LV

Model	Fan Speed	Watts	Btu/h	Watts	Btu/h	Order Code
		930	3173	541	1846	
1702	5807	991	3381			

LO-LINE RC

Model	Fan Speed	Watts	Btu/h	Watts	Btu/h	Order Code
		916	3126	564	1923	
1043	3558	641	2187			
1437	4904	883	3014			
LO-LINE RC 9-6	Normal	1358	4633	834	2847	LORC9
	Medium	1777	6064	1093	3728	
	Boost	2240	7643	1377	4699	
LO-LINE RC 14-10	Normal	2377	8111	1461	4986	LORC14
	Medium	2928	9989	1800	6140	
	Boost	3467	11829	2131	7272	
LO-LINE RC 19-15	Normal	3613	12327	2221	7578	LORC19
	Medium	4144	14140	2548	8692	
	Boost	4640	15831	2852	9731	

SLIM-LINE RC

Model	Fan Speed	Watts	Btu/h	Watts	Btu/h	Order Code	
		2290	7813	1340	4572		SLIMRC
		2870	9792	1710	5835		
3720	12693	2220	7575				

Heat outputs tested in accordance with BS 4856 Part 1.

Flow Rate (all products): 340 ltr/h (75 gal/h)

Flow Rate Correction Factors:
(HI-LINE RC, HI-LINE LV, LO-LINE RC & SLIM-LINE RC)

455 ltr/h (100 gal/h) multiply output by 1.06
227 ltr/h (50 gal/h) multiply output by 0.96
113 ltr/h (25 gal/h) multiply output by 0.85

Flow Rate Correction Factors:
(HI-LINE SUPER RC)

455 ltr/h (100 gal/h) multiply output by 1.03
227 ltr/h (50 gal/h) multiply output by 0.98
113 ltr/h (25 gal/h) multiply output by 0.85